



V200 POSITIONER

www.vacaccessories.com

1. WIRING DIAGRAMS

Screw terminals, overview

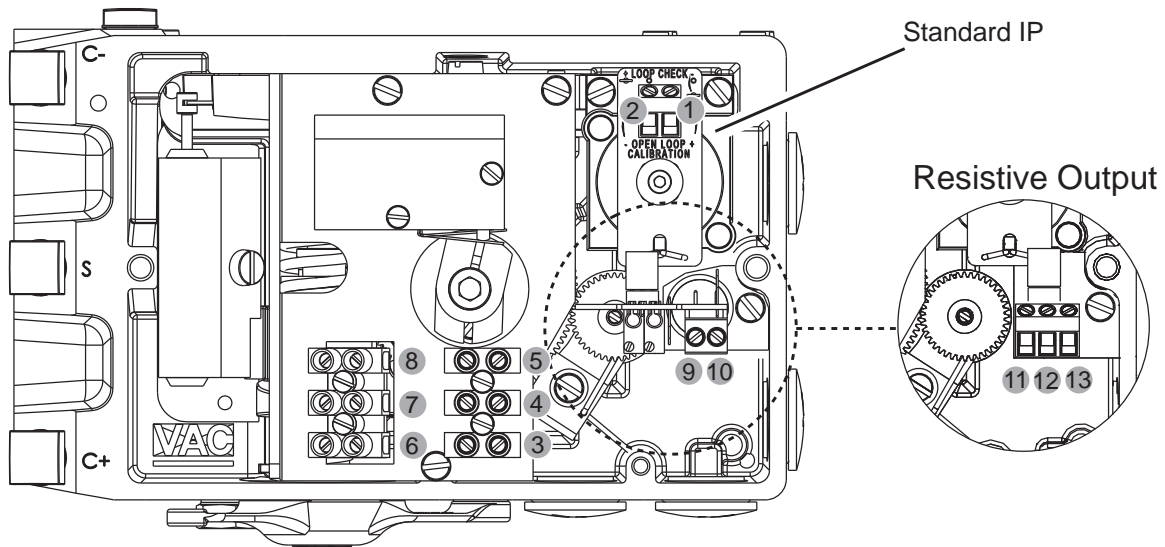

Terminal assignment

Standard IP

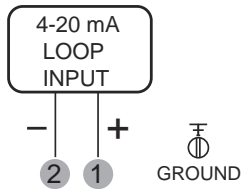

Loop Input
4 - 20 mA

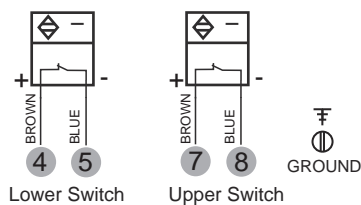

2 Inductive Sensors NAMUR
P+F NJ2-V3-N

Position Feedback

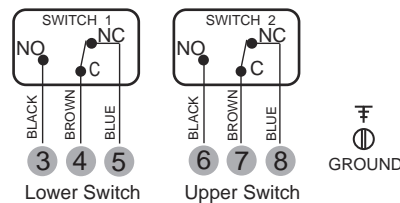

2 SPDT Mechanical Switches
Camden CMNS2020
Alternative
Cherry D45 (Form C)

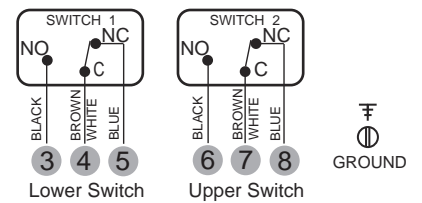

2 SPDT Magnetic sensors
Hamlin Reed 9145
Alternative
Cherry Reed MP2019 (Form C)

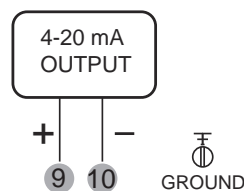

Current Output
4 - 20 mA

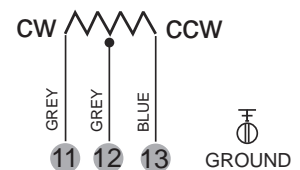

Resistive Output
0 - 10K ohm
0 - 1K ohm

